

1. Instruction manual ass'y - Accessories

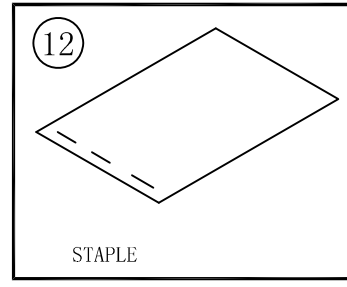

NO	DESCRIPTION	PARTS NO.	Q, ty
1	POLY BAG		1
2	CARD WARRANTY	CQE1A172X	1
3	HARMAN IMAGE BROCHURES		1
4	SHEET, IMPORTANT		1
5	INSTRUCTION MANUAL	visit harmankardon.com	1
6	BATTERY		2
7	CORD, PIN(3P, W/R/Y)	CJS4S004Z	1
8	CABLE, S-VHS (1.5M)	CJS01006Z	1
9	CORD, JACK (MONO) 1200MM	CJS9D002Z	1
10			
11	CABLE, HDMI (2M)	CJS8T001Z	1
12	STAPLE		3

2. Package Drawing

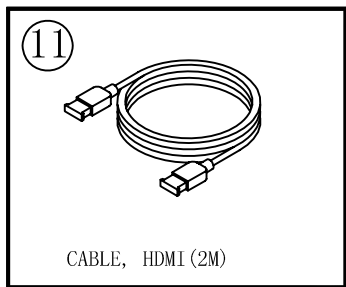
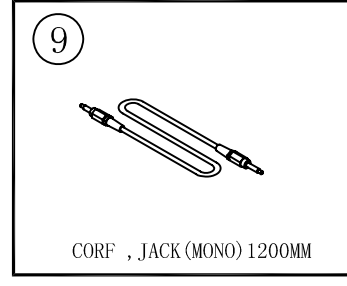
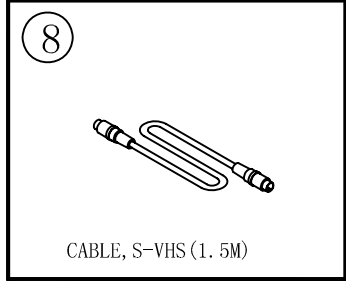
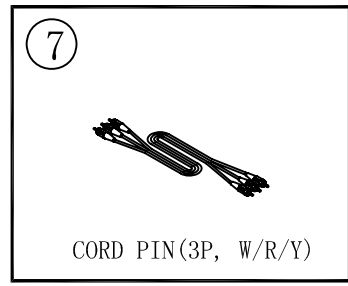
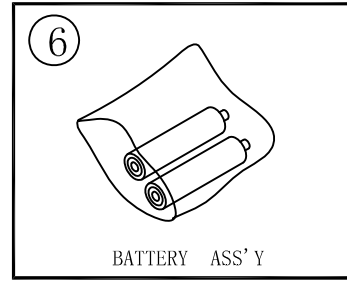
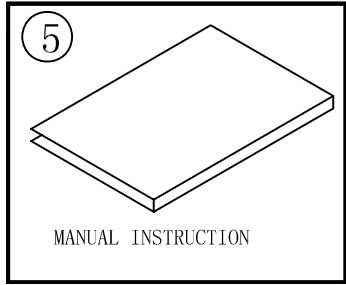
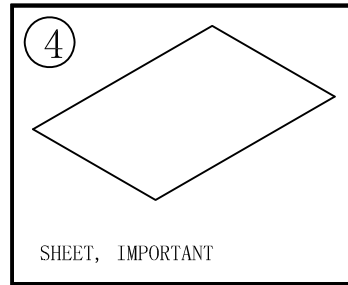
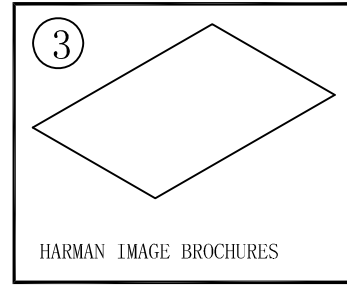
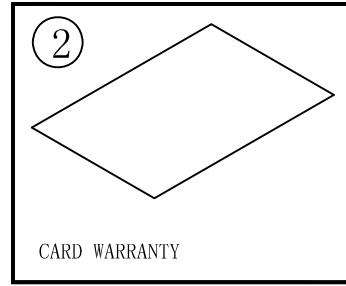
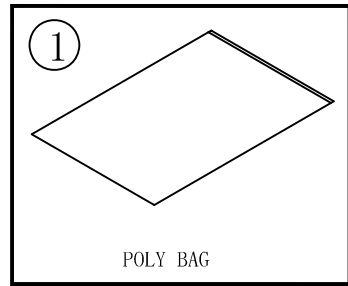
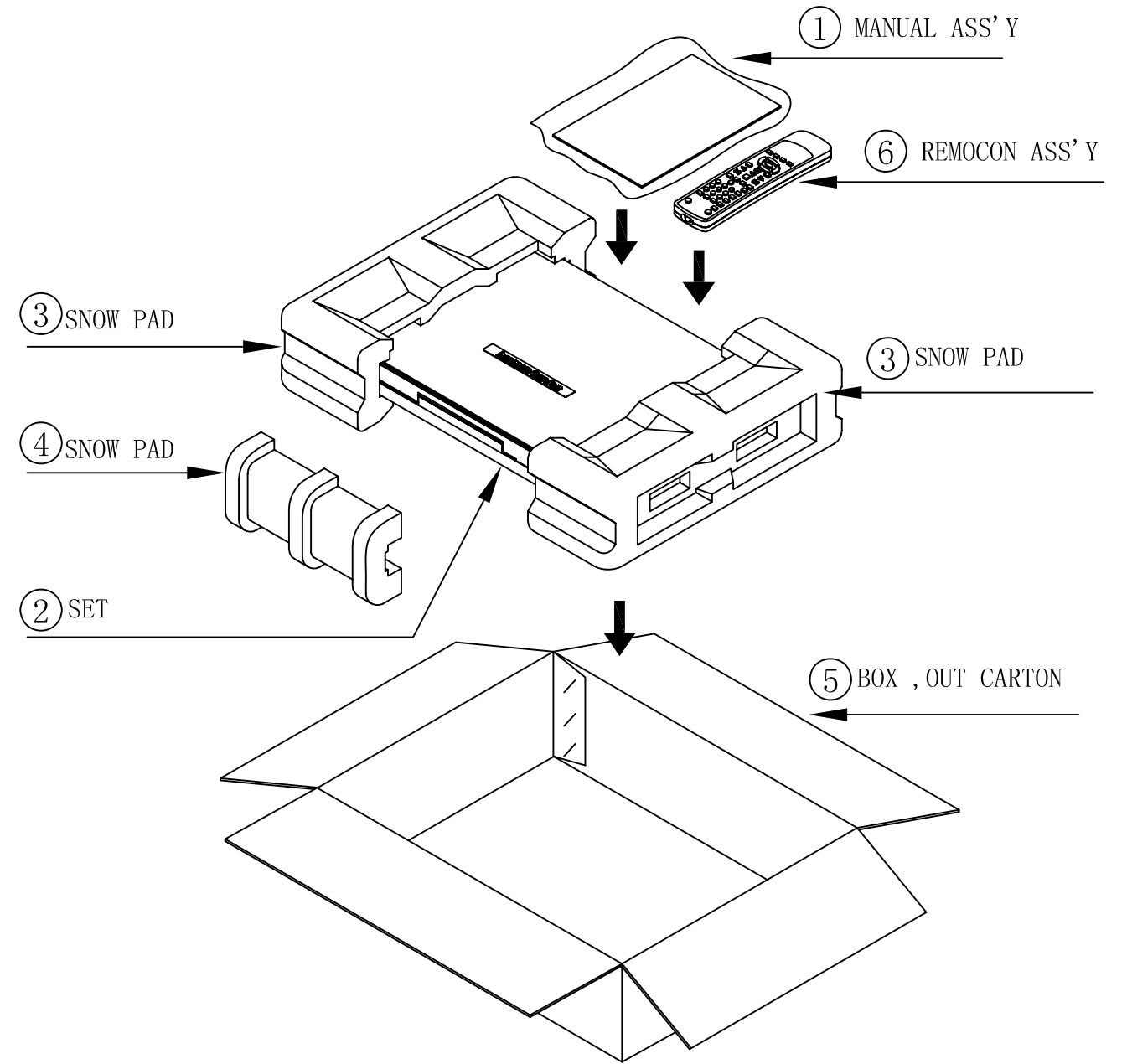

NO	DESCRIPTION	PARTS NO.	Q, ty
1	MANUAL ASS'Y		1
2	DVD 38	DVD 38	1
3	SNOW, PAD	CPS1A714	2
4	SNOW, PAD	CPS1A715	1
5	BOX, OUT CARTON	CPG1A798S	1
6	REMOCON ASS'Y	CARTDVD38	1
7			